

Data sheet | Item number: 286-721

Optocoupler module; Nominal input voltage: 24 VDC; Output voltage range: 15 ... 30 VDC; Limiting continuous current: 5 A; 3-wire connection/low-side switching; Red status indicator; Module width: 15 mm

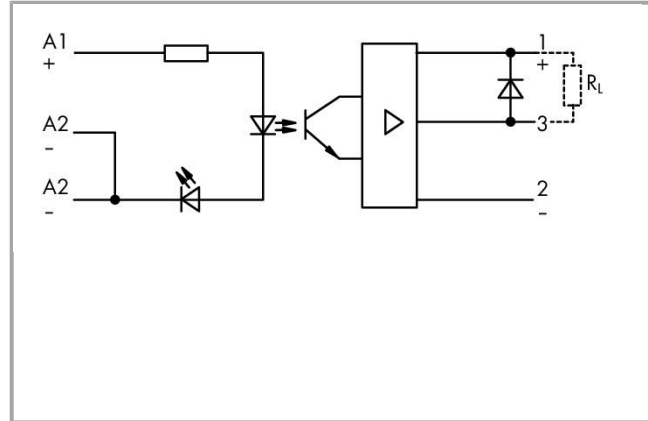

286-721



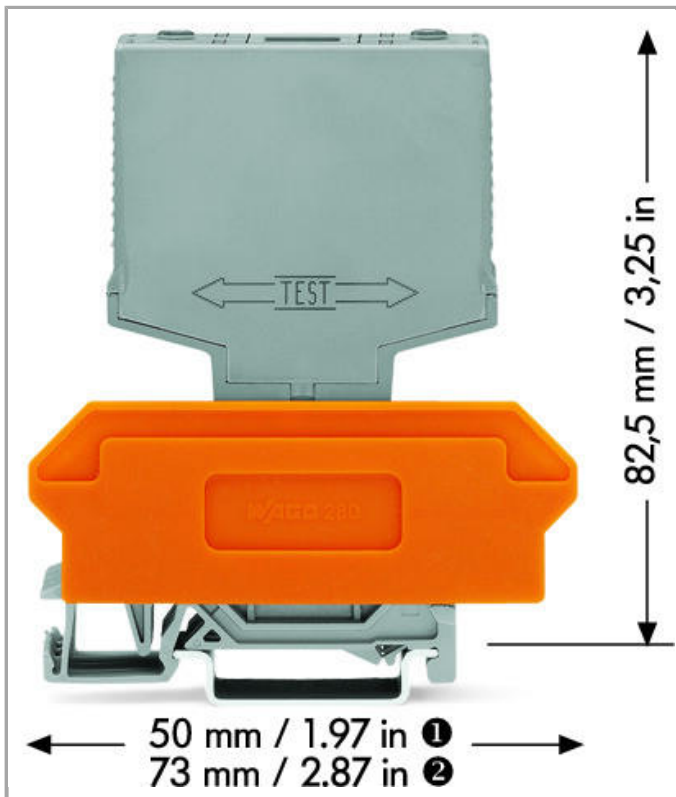

Data

Technical Data

Control circuit

Nominal input voltage U_N	DC 24 V
Input voltage range (high level)	DC 15 ... 30 V
Nominal input current at U_N	13.5 mA
Input current range	7.5 ... 18 mA

Load circuit:

Circuit type	3-conductor termination Low-side switching
Limiting continuous current	5 A
Output voltage range	DC 15 ... 40 V
Max. voltage drop at output	\leq DC 0.5 V
Leakage current at nominal voltage	\leq 2 μ A
Min. switching current	0 μ A
Turn-on time	\leq 20 μ s
Drop-out time	\leq 80 μ s
Switching frequency	\leq 1 kHz

Signaling

Status indication	LED red
-------------------	---------

Safety and protection:

Pollution degree	2
Dielectric strength, control/load circuit (AC, 1 min)	2.5 kVrms
Protection class	IP20

Geometrical Data

Width	15 mm / 0.591 inch
Height from upper-edge of DIN-35 rail	82.5 mm / 3.25 inch
Depth	52 mm / 1.654 inch

Mechanical data

Type of mounting	Pluggable module for carrier terminal blocks
------------------	--

Material Data

Color	gray
Fire load	0 MJ
Weight	29.2 g

Environmental Requirements

Pollution degree	3
Surrounding air (operating) temperature at U_N	-25 ... 40 °C
Surrounding air (storage) temperature	-25 ... 40 °C

Standards and specifications













Standards/specifications	EN 60664-1
--------------------------	------------

Commercial data

Product Group	6 (Interface Electronics)
Country of origin	DE
GTIN	4017332157735
Customs Tariff No.	85365005000

Compatible products

General accessories

	Item no.: 280-609 Terminal block for pluggable modules; 12-pole; with 4-conductor terminal blocks; with orange separator; for DIN-rail 35 x 15 and 35 x 7.5; 2.5 mm ² ; CAGE CLAMP®	280-609
	Item no.: 280-619 Terminal block for pluggable modules; 6-pole; with 2-conductor terminal blocks; with orange separator; for DIN-rail 35 x 15 and 35 x 7.5; 2.5 mm ² ; CAGE CLAMP®	280-619
	Item no.: 280-763 Terminal block for pluggable modules; 12-pole; with 4-conductor terminal blocks; with marker carrier; with orange separator; for DIN-rail 35 x 15 and 35 x 7.5; 2.5 mm ² ; CAGE CLAMP®	280-763
Marking accessories		
	Item no.: 209-701 WSB marking card; as card; not stretchable; plain; snap-on type	209-701
	Item no.: 209-701/000-002 WSB marking card; as card; not stretchable; plain; snap-on type	209-701 /000-002
	Item no.: 209-701/000-005 WSB marking card; as card; not stretchable; plain; snap-on type	209-701 /000-005
	Item no.: 209-701/000-006 WSB marking card; as card; not stretchable; plain; snap-on type	209-701 /000-006
	Item no.: 209-701/000-007 WSB marking card; as card; not stretchable; plain; snap-on type	209-701 /000-007
	Item no.: 209-701/000-012 WSB marking card; as card; not stretchable; plain; snap-on type	209-701 /000-012
	Item no.: 209-701/000-017 WSB marking card; as card; not stretchable; plain; snap-on type	209-701 /000-017
	Item no.: 209-701/000-023 WSB marking card; as card; not stretchable; plain; snap-on type	209-701 /000-023
	Item no.: 209-701/000-024 WSB marking card; as card; not stretchable; plain; snap-on type	209-701 /000-024

Downloads**Documentation****Bid Text**

268-721	Mar 9, 2016	doc	Download
Optokoppler		26.1 kB	

Additional Information



Subject to changes.
